

AccuForce 12V - 230Ah S

Solar VRLA Battery



Specifications

Nominal Voltage	12 V	
Number of cells	6	
Cycle Life	Approx. 800 cycles at 50% DOD	
Dimensions	Length	522 mm
	Width	238 mm
	Height	218 mm
	Total Height	221 mm
Approx. Weight	57.5 kg	
Nominal Capacity (25°C)	120 hours rate (1.95 A, 11.1 V)	234.0 Ah
	100 hours rate (2.30 A, 11.1 V)	230.0 Ah
	48 hours rate (4.51 A, 10.8 V)	216.5 Ah
	10 hours rate (20.00 A, 10.8 V)	200.0 Ah
	5 hours rate (35.00 A, 10.5 V)	175.0 Ah
Max. Discharge Current (25°C)	2000 A (5s)	
Internal Resistance	3.0 mOhms	
Fully Charged battery (25°C)	3.0 mOhms	
Self-Discharge	3% of capacity declined per month at 25°C (average)	
Operating Temperature Range	Discharge	-15°C~50°C
	Charge	-10°C~50°C
	Storage	-20°C~50°C
Short Circuit Current	3800 A	
Charging Characteristics (25°C)	Cycle use	2.40-2.48 Vpc
	Maximum charging current	60 A
	Temperature compensation	-30 mV/°C
	Standby use	2.27-2.35 Vpc
	Temperature compensation	-18 mV/°C
Design Floating Life (20°C)	10 years	

Applications

- Solar / Wind power systems
- Residential installations
- Golf carts and electric powered vehicles
- Marine equipment
- Electric wheelchairs
- Traffic systems (signaling and lighting)
- Remote monitoring and controlling
- Power tools and cleaning machines
- Uninterruptible power supply (UPS)

Battery Construction

Component	Positive Plate	Negative Plate	Container	Cover	Safety Valve	Terminal	Separator	Electrolyte
Raw material	Lead dioxide	Lead	ABS	ABS	Rubber	Copper	Fiberglass	Sulfuric acid

Dimensions

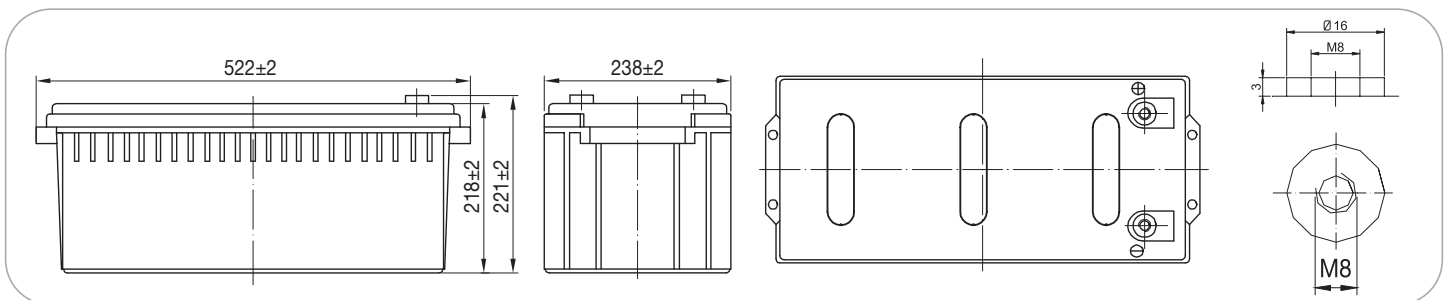

Constant Current Discharge (Amperes) at 25°C

End Voltage (Volts/Cell)	15min	30min	1h	2h	3h	4h	5h	6h	8h	10h	20h	48h	100h	120h
1.60 V	334	202	125	73.0	51.0	41.8	35.7	31.0	24.4	20.4	10.7	----	----	----
1.65 V	326	198	123	72.6	50.8	41.6	35.4	30.6	24.4	20.4	10.7	----	----	----
1.70 V	314	192	120	72.0	50.4	41.2	35.2	30.6	24.2	20.2	10.6	----	----	----
1.75 V	302	187	118	71.0	50.0	41.0	35.0	30.4	24.0	20.2	10.6	----	----	----
1.80 V	286	180	114	69.2	48.6	39.8	34.0	29.4	23.2	20.0	10.5	4.51	----	----
1.85 V	272	171	108	65.7	46.2	37.8	32.3	27.9	22.0	19.0	10.0	4.38	2.30	1.95

Constant Power Discharge (Watts) at 25°C

End Voltage (Volts/Cell)	15min	30min	1h	2h	3h	4h	5h	6h	8h	10h	20h	48h	100h	120h
1.60 V	3660	2246	1422	840	594	486	420	364	290	242	128	----	----	----
1.65 V	3572	2208	1404	836	592	484	416	362	290	242	128	----	----	----
1.70 V	3440	2144	1372	830	588	480	414	360	288	240	127	----	----	----
1.75 V	3322	2096	1344	820	584	478	410	356	286	240	127	----	----	----
1.80 V	3148	2024	1304	800	568	468	402	348	276	238	126	54.2	----	----
1.85 V	2991	1923	1239	760	540	445	382	331	262	226	120	52.2	27.4	23.3

Note: The above characteristics data can be obtained within three charge/discharge cycles.

AccuForce 12V - 230Ah S

Solar VRLA Battery

Typical Use Life and Operating Temperature

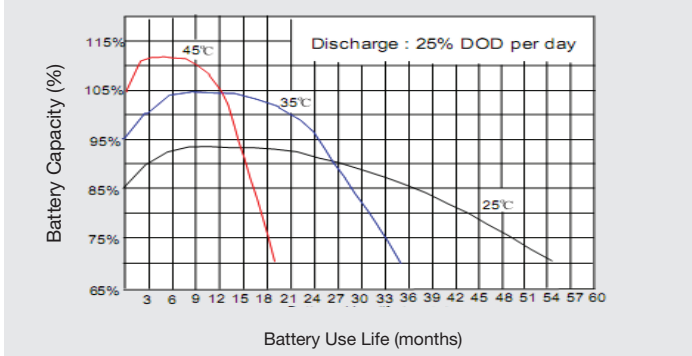

Self Discharge Characteristics

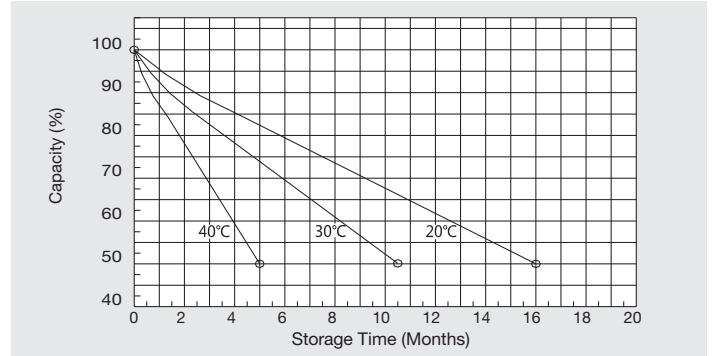

Discharge Characteristics (25°C)

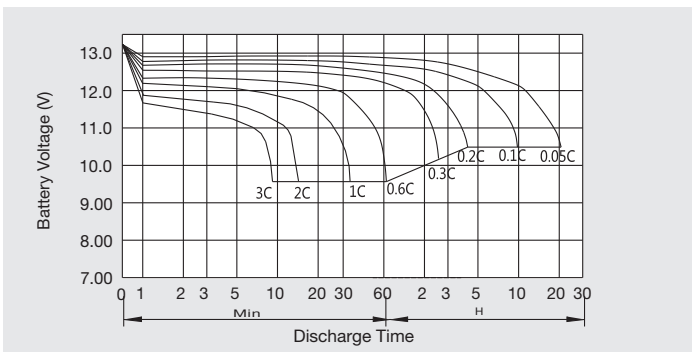

Charging Characteristics (25°C)

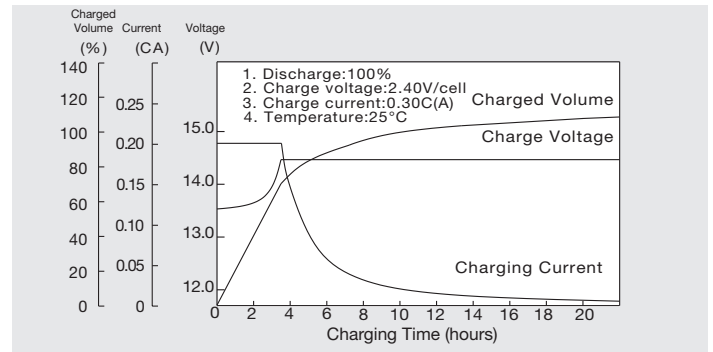

Relationship Between Charging Voltage and Temperature

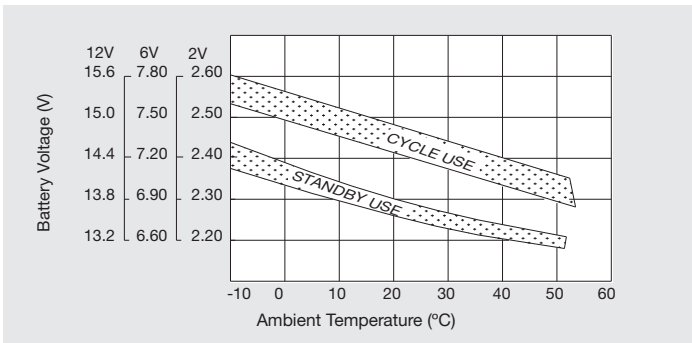

Relationship Between OCV and Residual Capacity (25°C)

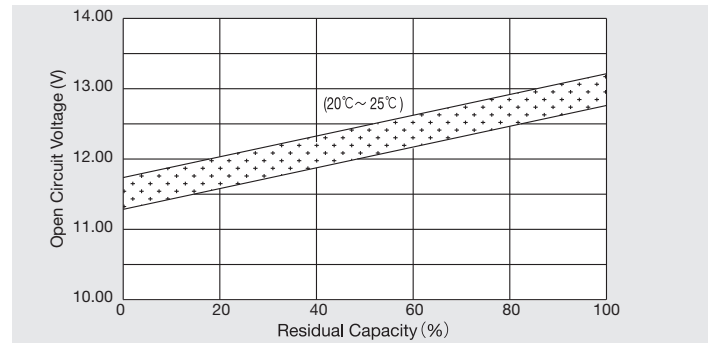

Cycle Service Life in Relation to Depth of Discharge

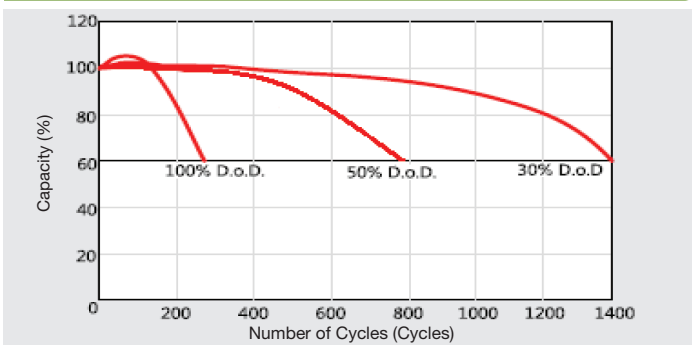

Temperature Effects on Capacity

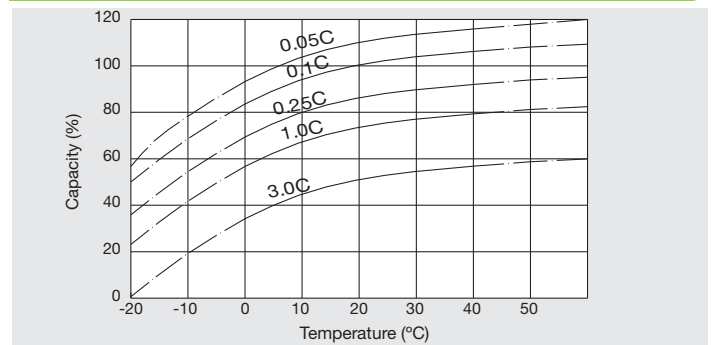

Headquarters 2 Ermou & Nikis Street | Syntagma Square | 105 63 | Athens | Greece | EU
 Manufacturing Plant Neo Olvio | 672 00 Xanthi | Greece | EU
 Recycling Plant Industrial Area of Komotini | 691 00 Komotini | Greece | EU
 Southeast Europe Industrial Sales 14B Menexedon Street | 145 64 Kato Kifissia | Greece | EU
 European Battery Assembly (SEBA) 175, Via Stra | 37030 Colognola Ai Colli Verona | Italy | EU
 Industrial SRL 11, Soseaua Centurii | 077025 Bragadiru, Judet Ilfov | Romania | EU

T +30 210 6245400
 T +30 25410 48100
 T +30 25310 82460
 T +30 210 6245600
 T +39 045 7651771
 T +40 021 3517777

F +30 210 6245409
 F +30 25410 95446
 F +30 25310 82489
 F +30 210 6245619
 F +39 045 7651771
 F +40 021 3516667