

AccuForce 12V - 175Ah S

Solar VRLA Battery



Specifications

Nominal Voltage	12 V	
Number of cells	6	
Cycle Life	Approx. 800 cycles at 50% DOD	
Dimensions	Length	485 mm
	Width	172 mm
	Height	240 mm
	Total Height	240 mm
Approx. Weight	42.8 kg	
Nominal Capacity (25°C)	120 hours rate (1.47 A, 11.1 V)	176.4 Ah
	100 hours rate (1.74 A, 11.1 V)	174.0 Ah
	48 hours rate (3.45 A, 10.8 V)	165.6 Ah
	10 hours rate (15.0 A, 10.8 V)	150.0 Ah
	5 hours rate (26.3 A, 10.5 V)	131.5 Ah
Max. Discharge Current (25°C)	1500 A (5s)	
Internal Resistance	3.5 mOhms	
Fully Charged battery (25°C)	3.5 mOhms	
Self-Discharge	3% of capacity declined per month at 25°C (average)	
Operating Temperature Range	Discharge	-15°C~50°C
	Charge	-10°C~50°C
	Storage	-20°C~50°C
Short Circuit Current	3400 A	
Charging Characteristics (25°C)	Cycle use	2.40-2.48 Vpc
	Maximum charging current	45 A
	Temperature compensation	-30 mV/°C
	Standby use	2.27-2.35 Vpc
Temperature compensation	-18 mV/°C	
Design Floating Life (20°C)	10 years	

Applications

- Solar / Wind power systems
- Residential installations
- Golf carts and electric powered vehicles
- Marine equipment
- Electric wheelchairs
- Traffic systems (signaling and lighting)
- Remote monitoring and controlling
- Power tools and cleaning machines
- Uninterruptible power supply (UPS)

Battery Construction

Component	Positive Plate	Negative Plate	Container	Cover	Safety Valve	Terminal	Separator	Electrolyte
Raw material	Lead dioxide	Lead	ABS	ABS	Rubber	Copper	Fiberglass	Sulfuric acid

Dimensions

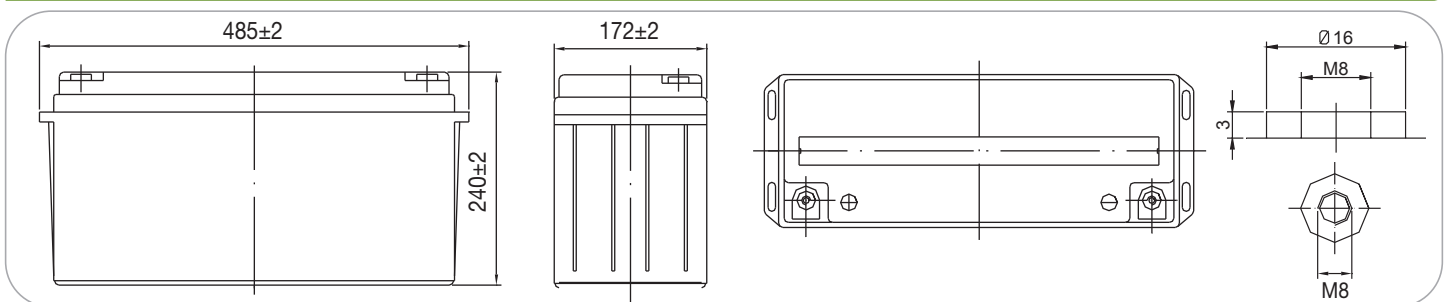

Constant Current Discharge (Amperes) at 25°C

End Voltage (Volts/Cell)	15min	30min	1h	2h	3h	4h	5h	6h	8h	10h	20h	48h	72h	100h	120h
1.60 V	251	152	93.8	54.8	38.3	31.3	26.8	23.3	18.3	15.3	8.01	---	---	---	---
1.65 V	244	149	92.6	54.4	38.1	31.1	26.6	22.9	18.3	15.3	7.99	---	---	---	---
1.70 V	236	144	90.2	54.0	37.9	30.9	26.4	22.9	18.2	15.2	7.99	3.51	---	---	---
1.75 V	227	140	88.3	53.3	37.5	30.8	26.3	22.9	18.0	15.2	7.93	3.28	2.34	---	---
1.80 V	214	135	85.7	51.9	36.4	29.8	25.5	22.1	17.4	15.0	7.88	3.45	2.33	---	---
1.85 V	201	128	80.4	48.8	34.1	27.9	24.0	20.8	16.4	14.1	7.41	3.24	2.19	1.74	1.47

Constant Power Discharge (Watts) at 25°C

End Voltage (Volts/Cell)	15min	30min	1h	2h	3h	4h	5h	6h	8h	10h	20h	48h	72h	100h	120h
1.60 V	2745	1684	1067	630	446	364	315	274	218	182	96.0	---	---	---	---
1.65 V	2679	1656	1054	626	444	364	311	270	218	182	95.8	---	---	---	---
1.70 V	2580	1609	1029	623	441	360	311	270	216	180	95.6	42.0	---	---	---
1.75 V	2492	1571	1009	615	439	358	308	266	214	180	95.3	41.8	28.1	---	---
1.80 V	2361	1519	979	600	426	351	302	261	206	179	94.5	41.4	27.9	---	---
1.85 V	2216	1425	919	563	399	328	283	244	193	168	88.9	39.0	26.3	21.0	17.6

Note: The above characteristics data can be obtained within three charge/discharge cycles.

AccuForce 12V - 175Ah S

Solar VRLA Battery

Typical Use Life and Operating Temperature

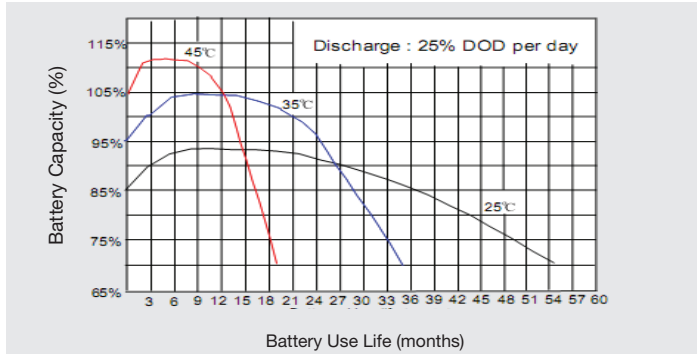

Self Discharge Characteristics

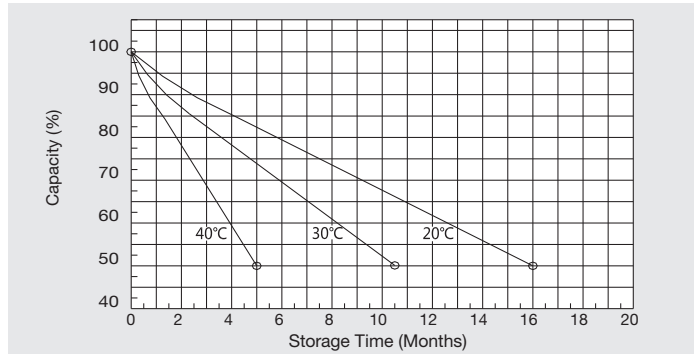

Discharge Characteristics (25°C)

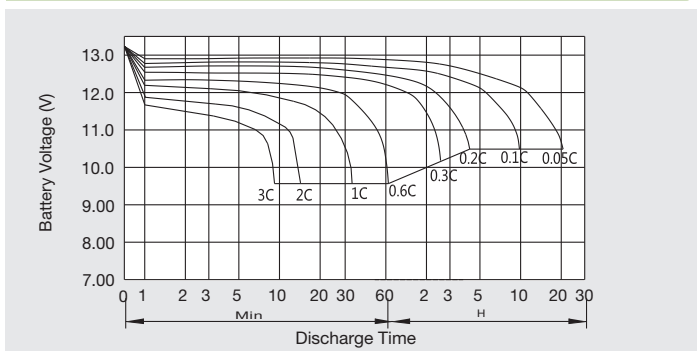

Charging Characteristics (25°C)

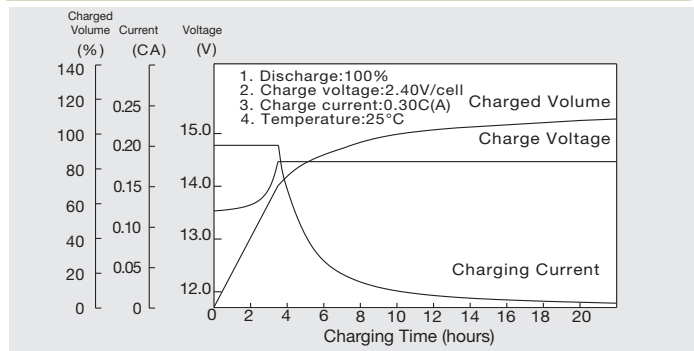

Relationship Between Charging Voltage and Temperature

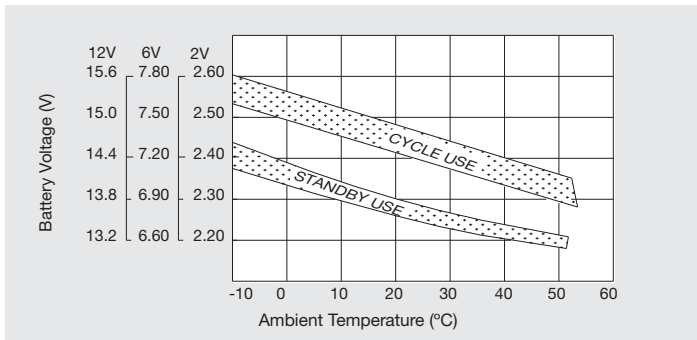

Relationship Between OCV and Residual Capacity (25°C)

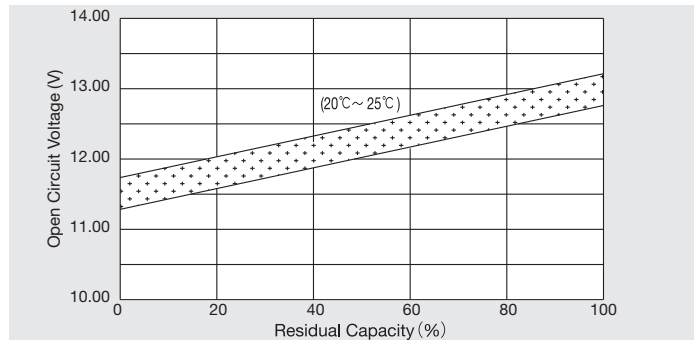

Cycle Service Life in Relation to Depth of Discharge

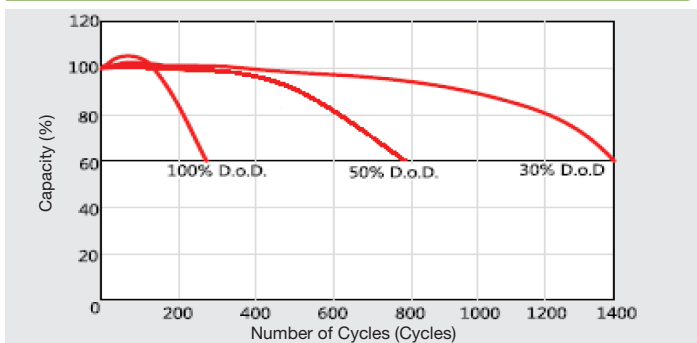

Temperature Effects on Capacity

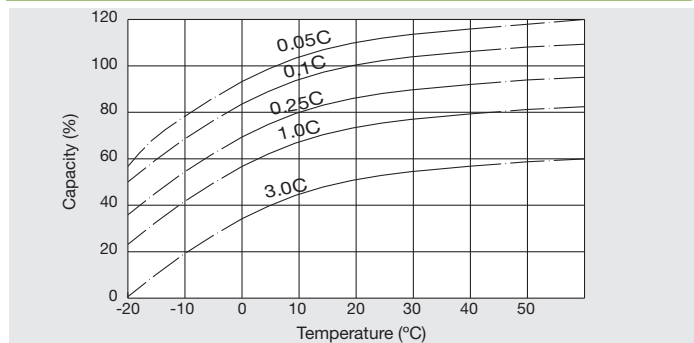

Headquarters 2 Ermou & Nikis Street | Syntagma Square | 105 63 | Athens | Greece | EU
Manufacturing Plant Neo Olvio | 672 00 Xanthi | Greece | EU
Recycling Plant Industrial Area of Komotini | 691 00 Komotini | Greece | EU
Southeast Europe Industrial Sales 14B Menexedon Street | 145 64 Kato Kifissia | Greece | EU
European Battery Assembly (SEBA) 175, Via Stra | 37030 Colognola Ai Colli Verona | Italy | EU
Industrial SRL 11, Soseaua Centurii | 077025 Bragadiru, Judet Ilfov | Romania | EU

T +30 210 6245400
T +30 25410 48100
T +30 25310 82460
T +30 210 6245600
T +39 045 7651771
T +40 021 3517777

F +30 210 6245409
F +30 25410 95446
F +30 25310 82489
F +30 210 6245619
F +39 045 7651771
F +40 021 3516667